

**HYUNDAI**  
POWER PRODUCTS

# PETROL MULTI-FUNCTION HCOMBID65

ORIGINAL INSTRUCTIONS

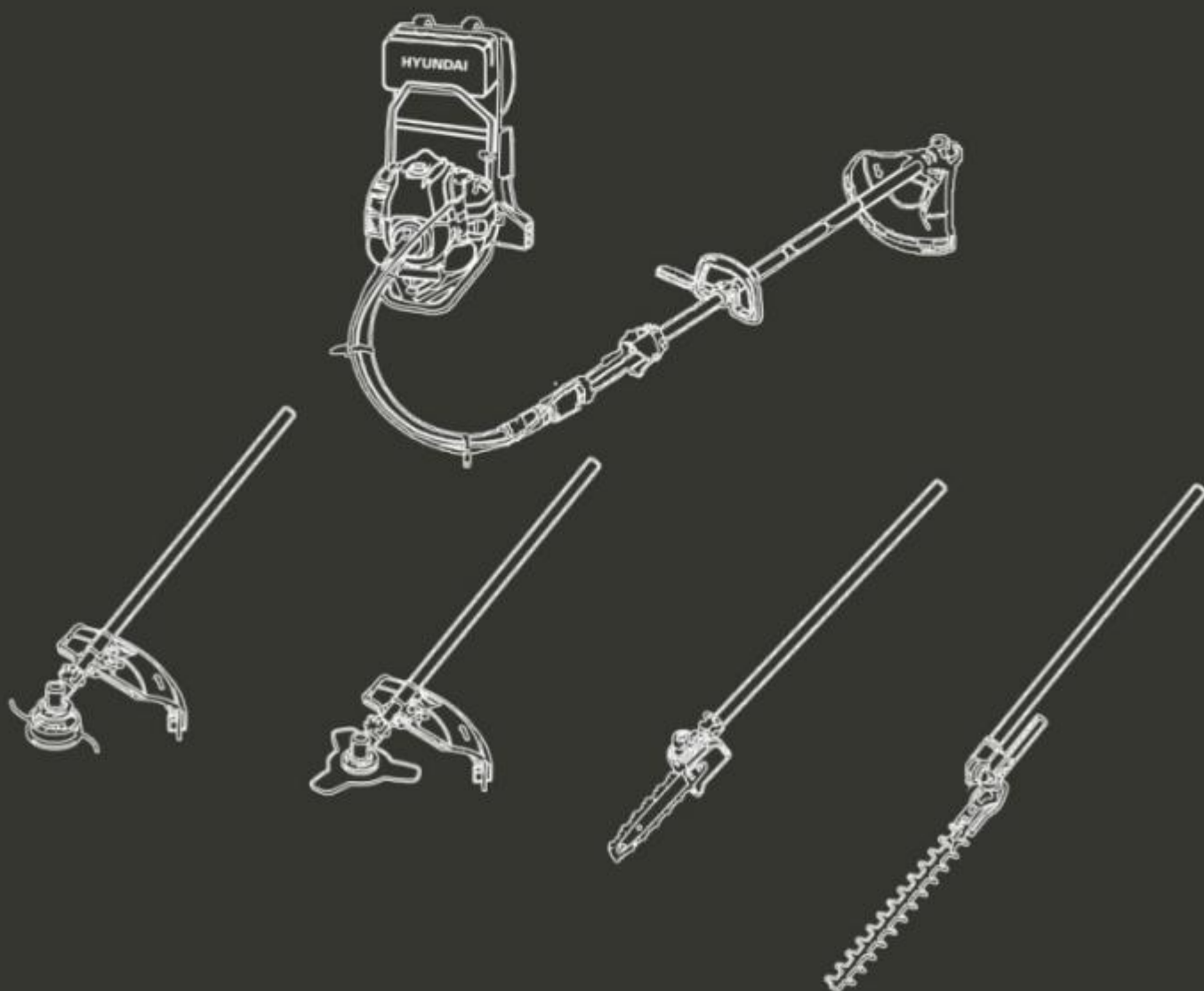

**WARNING:** Read the instructions manual before using the tool

# CONTENTS

1. SAFETY INSTRUCTIONS.....	3
2. YOUR PRODUCT.....	15
3. ASSEMBLY.....	18
4. FILLING OIL TANK AND FUEL TANK.....	22
5. OPERATION.....	23
6. MAINTENANCE.....	28
7. STORAGE.....	32
8. DISPOSAL AND RECYCLING.....	32
9. TROUBLESHOOTING.....	32
10. DECLARATION OF CONFORMITY.....	34
11. WARRANTY.....	35
12. PRODUCT FAILURE.....	36
13. WARRANTY EXCLUSIONS.....	37

# 1. SAFETY INSTRUCTIONS

## **Safety instructions for brushcutter and grass trimmer**

Proper safety precautions must be observed. This unit must be handled carefully. **DO NOT EXPOSE YOURSELF OR OTHERS TO DANGER.**

Follow these general rules. Do not permit others to use this machine unless they are thoroughly responsible and have read and understand the machine manual and are trained in its operation.

- Always wear safety goggles for eye protection. Dress properly; do not wear loose clothing or jewelry that could become caught in moving parts of the unit. Safe, sturdy, non-skid footwear should always be worn. Long hair should be tied back. It is recommended that legs and feet be covered to protect from flying debris during operation.
- Protective equipment must always be worn during the operation of the tool, including at least hearing protection, eyes protection, helmet, gloves, and mask of protection, slip-resistant foot protection, and protective clothes.
- Inspect the entire machine for loose parts (nuts, bolts, screws, etc.) and any damage. Repair or replace as necessary before using the machine. **DO NOT USE** any attachment other than the ones recommended by our company. Serious injury to the operator or bystanders could result as well as damage to the machine. Ask advice to your dealer or manufacturer. Do not use cutting attachment such as metal multi-piece pivoting chains and flail blades.
- Secure the machine during transport to prevent loss of fuel, damage or injury; always install the protection device on the blade, check the cap of the fuel tank, and do not transport the tool upside down.
- Keep the handles free from oil and fuel.
- Always use proper handles and shoulder strap when cutting.
- Do not smoke while mixing fuel or filling tank.
- Do not mix fuel in an enclosed room or near open flames. Assure adequate ventilation.
- Always mix and store the fuel in a properly marked container that is approved by local codes and ordinances for such usage.
- Never remove the fuel tank cap while the engine is running.
- Never start or run the engine inside a closed room or building. Fumes from the exhaust contain dangerous carbon monoxide.
- Never attempt to make engine adjustments while the unit is running and strapped to the operator. Always make engine adjustments with the unit resting on a flat, clear surface.
- Do not use the unit if it is damaged or poorly adjusted. Never remove the machine's guard. Serious injury to the operator or bystanders could result as well as damage to the machine.
- Inspect the area to be cut and remove all debris that could become entangled in the nylon cutting head. Also remove any objects that the unit may throw during cutting.
- Keep children away. Onlookers should be kept at a safe distance from the work area, at least 15 meters.
- Never leave the machine unattended.
- Do not use this unit for any job other than those for which it is intended as described in this manual.
- Do not overreach. Always keep proper footing and balance. Do not run the unit while standing on a ladder or on any other unstable footing location.
- Keep hands and feet clear of the nylon cutting head or blade while unit is in use.
- Do not use this type of machine for sweeping away debris.
- Do not use the unit when you are tired, ill or under the influence of medication, drugs or alcohol.
- Use nylon cutting head which is free of damage. If a stone or any other obstacle is hit, stop the engine and check the nylon cutting head. A broken or unbalanced nylon cutting head must never be used.

- Do not store in a closed area where fuel vapors can reach an open flame from hot water heaters, furnaces, etc. Store in a locked, well-ventilated area only.
- Ensure safe and proper performance of your product. These parts are available from your dealer. The use of any other accessories or attachments may cause injuries to the user, damage to the machine and void this warranty.
- When refueling, be sure to stop the engine and confirm that it is cooled down. Never refuel when the engine is running or hot. When gasoline spills, be sure to wipe it up completely dispose of those materials before starting the engine.
- Stay clear of other workers or bystanders by at least 15 meters.
- Whenever approaching an operator of the machine, carefully call his attention and confirm that the operator stops the engine. Be careful not to startle or distract the operator which can cause an unsafe situation.
- Never touch the nylon cutting head or blade whenever the engine is running. If it is necessary to replace the protector or cutting attachment, be sure to stop the engine and confirm that the cutting device has stopped running.
- The engine should be turned off when the machine is moved between work areas.
- Be careful not to hit the nylon cutting head against stones, or the ground.
- Unreasonable rough operation will shorten the life of the machine as well as create an unsafe environment for yourself and those around you.
- Pay attention to loosening and overheating of parts. If there is any abnormality of the machine, stop operation immediately and check the machine carefully. If necessary, have the machine serviced by an authorized dealer. Never continue to operate a machine which may be malfunctioning.
- In start-up or during operation of the engine, never touch hot parts such as the muffler, the high voltage wire or the spark plug.
- After the engine has stopped, the muffler is still hot. Never place the machine in any places where there are flammable materials (dry grass, etc.), combustible gases or combustible liquids.
- Pay special attention to operation in the rain or just after the rain as the ground may be slippery.
- If you slip or fall to the ground or into a hole, release the throttle lever immediately.
- Be careful not to drop the machine or hit it against obstacles.
- Before proceeding to adjust or repair the machine, be sure to stop the engine and detach the spark plug.
- When the machine is placed in storage for a long time, drain fuel from the fuel tank and carburetor, clean the parts, move the machine to a safe place and confirm that the engine is cooled down.
- Make periodic inspections to assure safe and efficient operation. For a thorough inspection of your machine, please contact a dealer.
- Keep the machine away from fire or sparks.
- It is believed that a condition called Raynaud's phenomenon, which affects the fingers of certain individuals, may be brought about by exposure to vibration and cold. Loss of colour and numbness in the fingers. The following precautions are strongly recommended because the minimum exposure which might trigger the ailment is unknown:
  - Keep your body warm, especially the head, neck, feet, ankles, hands and wrists.
  - Maintain good blood circulation by performing vigorous arm exercises during frequent work breaks and by not smoking.
  - Limit the hours of operation to avoid a prolonged exposition to the tool.
  - If you experience discomfort, redness and swelling of the fingers followed by whitening and loss of feeling, consult your physician before further exposing yourself to cold and vibration.
- Always wear ear protection, loud noise for long time can make hearing debase even lost hearing.
- Total face and head protection must be wearing to prevent damage from plummet or branch.

- Wear no-slip heavy duty work gloves to improve your grip on the brush cutter handle. Gloves also reduce the transmission of machine vibration to your hands.
- **WARNING:** The cutter area is still dangerous while the machine is coasting to a stop.
- During transport, this unit must be handled carefully. Do not expose yourself or others to danger.
- Envelop the blade before storage. Keep children away from it.
- Never remove the machine's guard.
- Clean and maintain the tool before storage (see the chapters on this manual). Bring maintenance after each use according the instructions of this manual. Improper maintenance can reduce the life of the tool, bring bad results and wear the tool and its accessories.
- Check the tool before and after use. Check for loose fasteners, fuel leaks and damaged parts, such as cracks in the cutting attachment. If the tool is damaged, if parts are missed or meet some dysfunctions, do not use the tool and bring it to a service agent for inspection and reparation.
- Check the tool after dropping or other impacts to identify any significant defects; if any defects are observed, stop to use the tool and bring it to a service agent for inspection and reparation.
- Do not store in a closed area where fuel vapors can reach an open flame from hot water heaters, furnaces, etc. Store in a locked, well-ventilated area only.
- Never place the machine in any places where there are flammable materials (dry grass, etc.), combustible gases or combustible liquids.
- When the machine is placed in storage for a long time, drain fuel from the fuel tank and carburetor, clean the parts, move the machine to a safe place and confirm that the engine is cooled down.
- **WARNING:** Be careful about exhaust gases; do not inhale them and do not expose people to these gases.
- National regulation can restrict the use of the machine.
- Never modify this tool.
- Improper use of the machine can cause **SERIOUS OR FATAL PERSONAL INJURY**.
- The exhaust gases of this product contain chemicals which can cause cancer, birth defects or other reproductive harm.
- Check regularly that the cutting attachment stops turning when the engine idles.
- Keep firm footing and balance during operation and always use the harness provided.

## **Kickback and Related Warnings**

- Kickback is a sudden reaction to a pinched or snagged rotating wheel, backing pad, brush or any other accessory. Pinching or snagging causes rapid stalling of the rotating accessory which in turn causes the uncontrolled power tool to be forced in the direction opposite of the accessory's rotation at the point of the binding.
- For example, if an abrasive wheel is snagged or pinched by the workpiece, the edge of the wheel that is entering into the pinch point can dig into the surface of the material causing the wheel to climb out or kick out. The wheel may either jump toward or away from the operator, depending on direction of the wheel's movement at the point of pinching. Abrasive wheels may also break under these conditions.
- Kickback is the result of power tool misuse and/or incorrect operating procedures or conditions and can be avoided by taking proper precautions as given below:
  - Never place your hand near the rotating accessory. Accessory may kickback over your hand.
  - Do not position your body in the area where power tool will move if kickback occurs. Kickback will propel the tool in direction opposite to the wheel's movement at the point of snagging.
  - Use special care when working corners, sharp edges etc. Avoid bouncing and snagging the accessory. Corners, sharp edges or bouncing tend to snag the rotating accessory and cause loss of control or kickback.

## **Residual risks**

Even if you use this tool correctly, there are always residual risks. The following hazards may arise in connection with the structure and manufacture of this power tool:

- Hearing impairment if no suitable hearing protection is worn.
- Cuts if no suitable protective clothing is worn.
- Health damage resulting from vibration in the hands and arms if the device is used for a long period of time or is not handled and maintained properly.
- Inhalation of particles.
- Inhalation of exhaust gases.
- Skin contact with oil / gasoline.
- Inhalation of gasoline / oil vapors.
- Contact with projected objects
- Burns when touching with hot surfaces
- Prolonged use of this product exposes the operator to vibration and can produce so-called "white finger" disease. To reduce the risk, wear gloves and keep your hands warm.
- If any of the symptoms of "white finger syndrome" occur, seek immediate medical attention. Symptoms of the "white finger" include numbness, loss of sensitivity, tingling, pain, loss of strength, colour changes or skin condition. These symptoms usually appear on the fingers, hands or wrists. Risk increases at low temperatures.
- Loss hearing in case of prolonged use and when a hearing protection is not worn.
- To minimize those risks, follow the instructions of this manual about wearing personal equipment of protection, take some rest during the operation and the manipulation of the tool. Do not work for a prolonged time.

## **Safety instructions for the hedge trimmer**

**WARNING!** Before using this tool, please read these instructions of safety and use. It will help you to use safely the machine and reduce the risk of electrical shocks and accidents. If you give this tool to another person, also give this manual.

Use this tool as described in this manual. Any mishandling and any use contrary to instructions will not in any way engage the liability of the manufacturer.

Non-compliance with safety instructions and use can cause a risk of electric shock, fire and / or injury to persons.

### **IMPORTANT**

**Read carefully before use**

**Keep for future reference**

## **Safe operating practices**

### **Training**

Become familiar with the owner's manual before attempting to operate the equipment.

### **Preparation**

- a) **THIS HEDGE TRIMMER CAN CAUSE SERIOUS INJURIES.** Read the instructions carefully for the correct handling, preparation, maintenance, starting and stopping of the hedge trimmer. Become familiar with all controls and the proper use of the hedge trimmer.
- b) Never allow children to use the hedge trimmer.
- c) Beware of overhead power lines.
- d) Avoid operating while people, especially children, are nearby.
- e) Dress properly! Do not wear loose clothing or jewellery, which can be caught in moving parts. Use of sturdy gloves, non-skid footwear and safety glasses is recommended.
- f) Use extra care when handling fuels. They are flammable and the vapors are explosive. The following points should be observed:

- Use only an approved container.
  - Never remove the fuel cap or add fuel with the power source running. Allow engine and exhaust components to cool down before refueling.
  - Do not smoke.
  - Never refuel indoors.
  - Never store the hedge trimmer or fuel container inside where there is an open flame, such as near a water heater.
  - If fuel is spilled, do not attempt to start the power source, but move the hedge trimmer away from the spillage before starting.
  - Always replace and securely tighten the fuel cap after refueling.
  - If the fuel tank is drained, this should be done outdoors.
- g) If the cutting mechanism strikes any foreign object or the hedge trimmer starts making any unusual noise or vibration, shut off the power source and allow the hedge trimmer to stop. Disconnect the spark plug and take the following steps:
- inspect for damage;
  - check for, and tighten, any loose parts;
  - have any damaged parts replaced or repaired with parts having equivalent specifications
- h) Wear ear protection.
- i) Wear eye protection.
- j) In case of emergency, stop the hedge trimmer; release the trigger, switch off the tool with the ON/OFF button. Let it completely stop and be cool before any intervention.

### **Operation**

Use the tool for the intended purpose and follow these provided instructions for use and maintenance.

- a) Stop the engine before:
- cleaning or when clearing a blockage,
  - checking, carrying out maintenance or working on the hedge trimmer,
  - adjusting the working position of the cutting device,
  - Leaving the hedge trimmer unattended.
- b) Ensure that the hedge trimmer is correctly located in a designated working position before starting the engine.
- c) While operating the hedge trimmer, always ensure that the operating position is safe and secure, especially when using steps or a ladder.
- d) Do not operate the hedge trimmer with a damaged or excessively worn cutting device.
- e) To reduce fire hazards, keep the engine and silencer free of debris, leaves and excessive lubricant.
- f) Always ensure that all handles and guards are fitted when using the hedge trimmer. Never attempt to use an incomplete hedge trimmer or one fitted with an unauthorized modification.
- g) Always use two hands to operate a hedge trimmer fitted with two handles.
- h) Always pay attention to those around you and stay alert about possible hazards that you may not be aware of due to the noise of the hedge trimmer.

### **Maintenance and storage**

- a) When the hedge trimmer is stopped for servicing, inspection or storage, shut off the power source, disconnect the spark plug wire from the spark plug and make sure all moving parts have come to a stop. Allow the hedge trimmer to cool before making any inspections, adjustments, etc.
- b) Store the hedge trimmer where the fuel vapour will not reach an open flame or spark. Always allow the hedge trimmer to cool down before storing.
- c) When transporting or storing the hedge trimmer, always fit the cutting device transport guard.

## **Additional instructions**

- Warning - Never allow children to use the hedge trimmer.
- Work only during in the day or with an enough artificial light.
- Before starting to work, check the condition of the tool.
- Ensure that all the parts of the machine are well fixed and tightened.
- Control regularly that the blade of cut is in good state.
- Always hold firmly the hedge trimmer with the two hands.
- Never take or hold the hedge trimmer by the blade.
- Maintain clothing out of reach blade.
- Keep the device distant from all shapes of sparks, flames and flammable materials.
- Control that the working areas are free from all shapes of obstacles.
- Work with precaution, be not distracted.
- Do not use the tool when you are under the influence of alcohol, meds or drugs, and where you are sick and tired.
- Dry all possible gasoline traces by using a dry rag.
- In case of accident, immediately stop using the machine. Check the problem. Do not use the machine while the machine is damaged.
- Operate the machine only at reasonable hours – not early in the morning or late at night when people might be disturbed;
- When blockage occurs, immediately turn off the engine with the ON/OFF button. Let the tool cool down. Check and correct the blockage before starting again to work. Use gloves when clearing a blockage. Restart the machine securely when the machine is totally unblocked.
- When a danger or a non-intended situation arise, stop to work immediately and switch off the tool. Restart to work when there is no danger and you can work safely.
- Cut before the large branches with a hand shears to avoid the blocking of the blade.
- Pay attention not to cut iron wire or others.
- Do not use non-recommended accessories with this tool. To replace any piece of this tool, please contact the retailer, service agent or manufacturer.
- Use only the mixture recommended by the manufacturer.
- Store the mixture in a specific container for the gasoline.
- Keep the device in a quite dry place and out of reach of children.
- Store the mixture only on free air or in a well-ventilated place. Handle the fuel with precaution, it is highly flammable.
- Do not smoke or use telephone when you handle gasoline.
- Use a funnel and fill the tank only when the engine is cold.
- Do not open the tank if the engine is hot or under operation.
- Keep people and yourself far away from the exhaust to avoid the risks of burns.
- Maintain the people and the animals far away from the working area.
- Always remind that this machine can cause very serious incidents.
- Do not work under the rain and/or in places wet and/or slipping.
- Do not expose to the rain.
- Do not use the tool during bad weather conditions and where a risk of lighting is possible.
- Use complete personal protective equipment during the use of the tool: gloves, antiskid footwear, helmet, eyes protection, protection clothes, and mask of protection.
- Do not use the machine when you are tired, under the influence of alcohol or drugs or sick.
- The machinery must not be used in a way where experience has shown that danger and/or risks might occur.
- Never use hedge trimmer inside a building. Your hedge trimmer produces toxic exhaust fumes as soon as the engine is started. The use of this product can generate dust, vapors and smoke containing chemicals known for their harmful effects on health. So be careful during the use of



your machine and protect yourself correctly. Also avoid voluntarily breathing exhaust fumes; always hold the machine correctly when you use it.

- Regularly lubricate the blades of the trimmer by using a lubricant which is sold in specialized stores.

### **Residual risks**

Even if you use this product in compliance with all safety requirements, the potential risks of injury and damage remain. The following hazards may arise in the structure and design of this product. Always be vigilant when using this product, so you can recognize and manage the risks rather. Rapid intervention can prevent serious injury and property damage.

- There are harmful health consequences resulting from the emission of vibrations if the product is used for long periods of time or not properly managed and properly maintained.
- There is risk of injury and property damage due to attachments or broken the sudden impact of hidden objects.
- Risk of injury to persons and property caused by flying objects.
- Prolonged use of this product exposes the operator to vibration and can produce so-called “white finger” disease. To reduce the risk, wear gloves and keep your hands warm. If any of the symptoms of “white finger syndrome” occur, seek immediate medical attention. Symptoms of the “white finger” include numbness, loss of sensitivity, tingling, tingling, and pain, loss of strength, colour changes or skin condition. These symptoms usually appear on the fingers, hands or wrists. Risk increases at low temperatures
- Inhalation of particles
- Inhalation of exhaust gases
- Unattended projections
- Contact with foreign objects
- Contact with the tool in operation
- Hearing loss in the absence of correct hearing protection

To minimize those risks, follow the instructions of this manual about wearing personal equipment of protection and the manipulation of the tool. Take some rest during the operation. Do not work for a prolonged time.

### **Safety warnings for the mounted pole pruner**

Proper safety precautions must be observed. This unit must be handled carefully. **DO NOT EXPOSE YOURSELF OR OTHERS TO DANGER.**

Follow these general rules. Do not permit others to use this machine unless they are thoroughly responsible and have read and understand the machine manual and are trained in its operation.

- Always wear safety goggles for eye protection. Dress properly; do not wear loose clothing or jewelry that could become caught in moving parts of the unit. Safe, sturdy, non-skid footwear should always be worn. Long hair should be tied back. It is recommended that legs and feet be covered to protect from flying debris during operation.
- Protective equipment must always be worn during the operation of the tool, including at least hearing protection, eyes protection, helmet, gloves, and mask of protection, slip-resistant foot protection, and protective clothes.
- Inspect the entire machine for loose parts (nuts, bolts, screws, etc.) and any damage. Repair or replace as necessary before using the machine. **DO NOT USE** any attachment other than the ones recommended by our company. Serious injury to the operator or bystanders could result as well as damage to the machine. Ask advice to you dealer of manufacturer. Do not use cutting attachment such as metal multi-piece pivoting chains and flail blades.
- Secure the machine during transport to prevent loss of fuel, damage or injury; always install the protection device on the blade, check the cap of the fuel tank, and do not transport the tool upside down.

- Keep the handles free from oil and fuel.
- Always use proper handles and shoulder strap when cutting.
- Do not smoke while mixing fuel or filling tank.
- Do not mix fuel in an enclosed room or near open flames. Assure adequate ventilation.
- Always mix and store the fuel in a properly marked container that is approved by local codes and ordinances for such usage.
- Never remove the fuel tank cap while the engine is running.
- Never start or run the engine inside a closed room or building. Fumes from the exhaust contain dangerous carbon monoxide.
- Never attempt to make engine adjustments while the unit is running and strapped to the operator. Always make engine adjustments with the unit resting on a flat, clear surface.
- Do not use the unit if it is damaged or poorly adjusted. Never remove the machine's guard. Serious injury to the operator or bystanders could result as well as damage to the machine.
- Inspect the area to be cut and remove all debris that could become entangled in the nylon cutting head. Also remove any objects that the unit may throw during cutting.
- Keep children away. Onlookers should be kept at a safe distance from the work area, at least 15 meters.
- Never leave the machine unattended.
- Do not use this unit for any job other than those for which it is intended as described in this manual.
- Do not overreach. Always keep proper footing and balance. Do not run the unit while standing on a ladder or on any other unstable footing location.
- Keep hands and feet clear of the nylon cutting head or blade while unit is in use.
- Do not use this type of machine for sweeping away debris.
- Do not use the unit when you are tired, ill or under the influence of medication, drugs or alcohol.
- Do not store in a closed area where fuel vapors can reach an open flame from hot water heaters, furnaces, etc. Store in a locked, well-ventilated area only.
- Ensure safe and proper performance of your product. These parts are available from your dealer. The use of any other accessories or attachments may cause a potential hazard or injury to the user, damage to the machine and void this warranty.
- When refueling, be sure to stop the engine and confirm that it is cooled down. Never refuel when the engine is running or hot. When gasoline spills, be sure to wipe it up completely dispose of those materials before starting the engine.
- Stay clear of other workers or bystanders by at least 15 meters.
- Whenever approaching an operator of the machine, carefully call his attention and confirm that the operator stops the engine. Be careful not to startle or distract the operator which can cause an unsafe situation.
- Never touch the nylon cutting head or blade whenever the engine is running. If it is necessary to replace the protector or cutting attachment, be sure to stop the engine and confirm that the cutting device has stopped running.
- The engine should be turned off when the machine is moved between work areas.
- Be careful not to hit the nylon cutting head against stones, or the ground.
- Unreasonable rough operation will shorten the life of the machine as well as create an unsafe environment for yourself and those around you.
- Pay attention to loosening and overheating of parts. If there is any abnormality of the machine, stop operation immediately and check the machine carefully. If necessary, have the machine serviced by an authorized dealer. Never continue to operate a machine which may be malfunctioning.
- In start-up or during operation of the engine, never touch hot parts such as the muffler, the high voltage wire or the spark plug.

- After the engine has stopped, the muffler is still hot. Never place the machine in any places where there are flammable materials (dry grass, etc.), combustible gasses or combustible liquids.
- Pay special attention to operation in the rain or just after the rain as the ground may be slippery.
- If you slip or fall to the ground or into a hole, release the throttle lever immediately.
- Be careful not to drop the machine or hit it against obstacles.
- Before proceeding to adjust or repair the machine, be sure to stop the engine and detach the spark plug.
- When the machine is placed in storage for a long time, drain fuel from the fuel tank and carburetor, clean the parts, move the machine to a safe place and confirm that the engine is cooled down.
- Make periodic inspections to assure safe and efficient operation. For a thorough inspection of your machine, please contact a dealer.
- Keep the machine away from fire or sparks.
- It is believed that a condition called Raynaud's phenomenon, which affects the fingers of certain individuals, may be brought about by exposure to vibration and cold. Loss of color and numbness in the fingers. The following precautions are strongly recommended because the minimum exposure which might trigger the ailment is unknown:
  - Keep your body warm, especially the head, neck, feet, ankles, hands and wrists.
  - Maintain good blood circulation by performing vigorous arm exercises during frequent work breaks and by not smoking.
  - Limit operating hours to avoid prolonged exposure to the tool.
  - If you experience discomfort, redness and swelling of the fingers followed by whitening and loss of feeling, consult your physician before further exposing yourself to cold and vibration.
- Always wear ear protection, loud noise for long time can make hearing debased even lost hearing.
- Total face and head protection must be wearing to prevent damage from plummet or branch.
- Wear no-slip heavy duty work gloves to improve your grip on the brush cutter handle. Gloves also reduce the transmission of machine vibration to your hands.
- **WARNING:** The cutter area is still dangerous while the machine is coasting to a stop.
- When transport, this unit must be handled carefully. Do not expose yourself or others to danger.
- Envelop the blade before storage. Keep children away from it.
- Never remove the machine's guard.
- Clean and maintain the tool before storage (see the chapters on this manual). Bring maintenance after each use according the instructions of this manual. Improper maintenance can reduce the life of the tool, bring bad results and wear the tool and its accessories.
- Check the tool before and after use. Check for loose fasteners, fuel leaks and damaged parts, such as cracks in the cutting attachment. If the tool is damaged, if parts are missed or meet some dysfunctions, do not use the tool and bring it to a service agent for inspection and reparation.
- Check the tool after dropping or other impacts to identify any significant defects; if any defects are observed, stop to use the tool and bring it to a service agent for inspection and reparation.
- Do not store in a closed area where fuel vapors can reach an open flame from hot water heaters, furnaces, etc. Store in a locked, well-ventilated area only.
- Never place the machine in any places where there are flammable materials (dry grass, etc.), combustible gasses or combustible liquids.
- When the machine is placed in storage for a long time, drain fuel from the fuel tank and carburetor, clean the parts, move the machine to a safe place and confirm that the engine is cooled down.
- Warning – Be careful about exhaust gases; do not inhale them and do not expose people to these gases.
- National regulation can restrict the use of the machine.

- Never modify the tool in any way.
- Improper use of the machine can cause **SERIOUS OR FATAL PERSONAL INJURY**.
- The engine exhaust from this product contains chemicals to cause cancer, birth defects, or other reproductive harm.
- Check regularly that the cutting attachment stops turning when the engine idles.
- Warning: there is a danger of using the machine near overhead electric power lines.
- Warning: there is a risk of being struck by falling branches.
- Warning: avoid dangerous positions in order to avoid accidents.
- keep firm footing and balance during operation.

## **Kickback and Related Warnings**

- Kickback is a sudden reaction to a pinched or snagged rotating wheel, backing pad, brush or any other accessory. Pinching or snagging causes rapid stalling of the rotating accessory which in turn causes the uncontrolled power tool to be forced in the direction opposite of the accessory's rotation at the point of the binding.
- For example, if an abrasive wheel is snagged or pinched by the workpiece, the edge of the wheel that is entering into the pinch point can dig into the surface of the material causing the wheel to climb out or kick out. The wheel may either jump toward or away from the operator, depending on direction of the wheel's movement at the point of pinching. Abrasive wheels may also break under these conditions.
- Kickback is the result of power tool misuse and/or incorrect operating procedures or conditions and can be avoided by taking proper precautions as given below:
  - Never place your hand near the rotating accessory. Accessory may kickback over your hand.
  - Do not position your body in the area where power tool will move if kickback occurs. Kickback will propel the tool in direction opposite to the wheel's movement at the point of snagging.
  - Use special care when working corners, sharp edges etc. Avoid bouncing and snagging the accessory. Corners, sharp edges or bouncing tend to snag the rotating accessory and cause loss of control or kickback.

## **Residual risks**

Even if you use this product in compliance with all safety requirements, the potential risks of injury and damage remain. The following hazards may arise in the structure and design of this product. Always be vigilant when using this product, so you can recognize and manage the risks rather. Rapid intervention can prevent serious injury and property damage.

- There are harmful health consequences resulting from the emission of vibrations if the product is used for long periods of time or not properly managed and properly maintained.
- There is risk of injury and property damage due to attachments or broken the sudden impact of hidden objects.
- Risk of injury to persons and property caused by flying objects.
- Prolonged use of this product exposes the operator to vibration and can produce so-called "white finger" disease. To reduce the risk, wear gloves and keep your hands warm. If any of the symptoms of "white finger syndrome" occur, seek immediate medical attention. Symptoms of the "white finger" include numbness, loss of sensitivity, tingling, tingling, and pain, loss of strength, color changes or skin condition. These symptoms usually appear on the fingers, hands or wrists. Risk increases at low temperatures
- Inhalation of particles
- Inhalation of exhaust gases
- Unattended projections
- Contact with foreign objects
- Contact with the tool in operation
- Hearing loss in the absence of correct hearing protection

To minimize those risks, follow the instructions of this manual about wearing personal equipment of protection, take some rest during the operation and the manipulation of the tool. Do not work for a prolonged time.

## **Intended use**

### **1) Brushcutter and grass trimmer**

This machine can be used as a grass trimmer with the sharp nylon line, and as a brush cutter with the cutting blade. When using the machine with the sharp nylon line, use it strictly and only as a trimmer to cut grass or loose weeds.

When using the machine with the cutting blade, use it only as a brush cutter, to cut tough grass, denser weeds as well as small branches with a maximum diameter of 10mm.

This machine is not intended for cutting bushes or other similar plants that require the machine or cutting tool to be lifted off the ground.

Do not use this tool to work with other materials such as stones, clay soils, etc.

### **2) Mounted pole pruner**

The pole pruner is exclusively intended for pruning trees and/or cutting small wood from the ground. Any other use is considered improper and will damage the tool.





The correct use also includes reading and observing the instructions for use at each use as well as observing the warnings fixed on the machine. Before and during use, it is imperative to check the blade to ensure that there is no mechanical damage. In case of necessary repairs, please contact your specialist dealer.















Only the use of spare parts approved by the manufacturer or original spare parts is permitted. If unauthorized or non-original spare parts are used, the user is liable for consequential injury to persons or property resulting in the manufacturer being deprived of all liability.

### **3) Hedge trimmer**

Your hedge trimmer is a device used by a person to trim hedges and shrubs by working with one or more blades arranged linearly and back and forth. A potential hazard exists if the device is used for other purposes. Improper handling of the hedge trimmer increases the risk of injury from blades. Only the use of spare parts and accessories approved by the manufacturer is permitted.

## **Symbols**

	Read instructions manual.
	Wear protective equipment: hearing protection, eye protection, and helmet.
	Wear eye protection.
	Wear protection gloves.
	Wear hearing protection.

	Wear protective footwear.
	Caution to exhaust gases.
	Caution – Risk of fire.
	Do not smoke and do use the tool near naked flame.
	The accessible part are hot when operate the tool.
	Caution! Risk of rebound.
	Warning – Risk of electric shock. Always beware of the danger from overhead electric-power line, keep a safe distance at least 10m from the power line.
	Caution! The tool can contact voluminous material. Loss of control and injuries can be created.
	Warning – Risk of projection. Keep bystander away.
	Guarantee sound power level.
	Be careful of the cutting attachment!
	Do not use saw blades.
	Before maintenance and servicing, wait for a complete stop of the tool and unplug the spark plug. Read the instruction manual.
	Keep bystander away, at least 15m.
	Do not use under rain and in damp environment.

## 2. YOUR PRODUCT

### a. Description

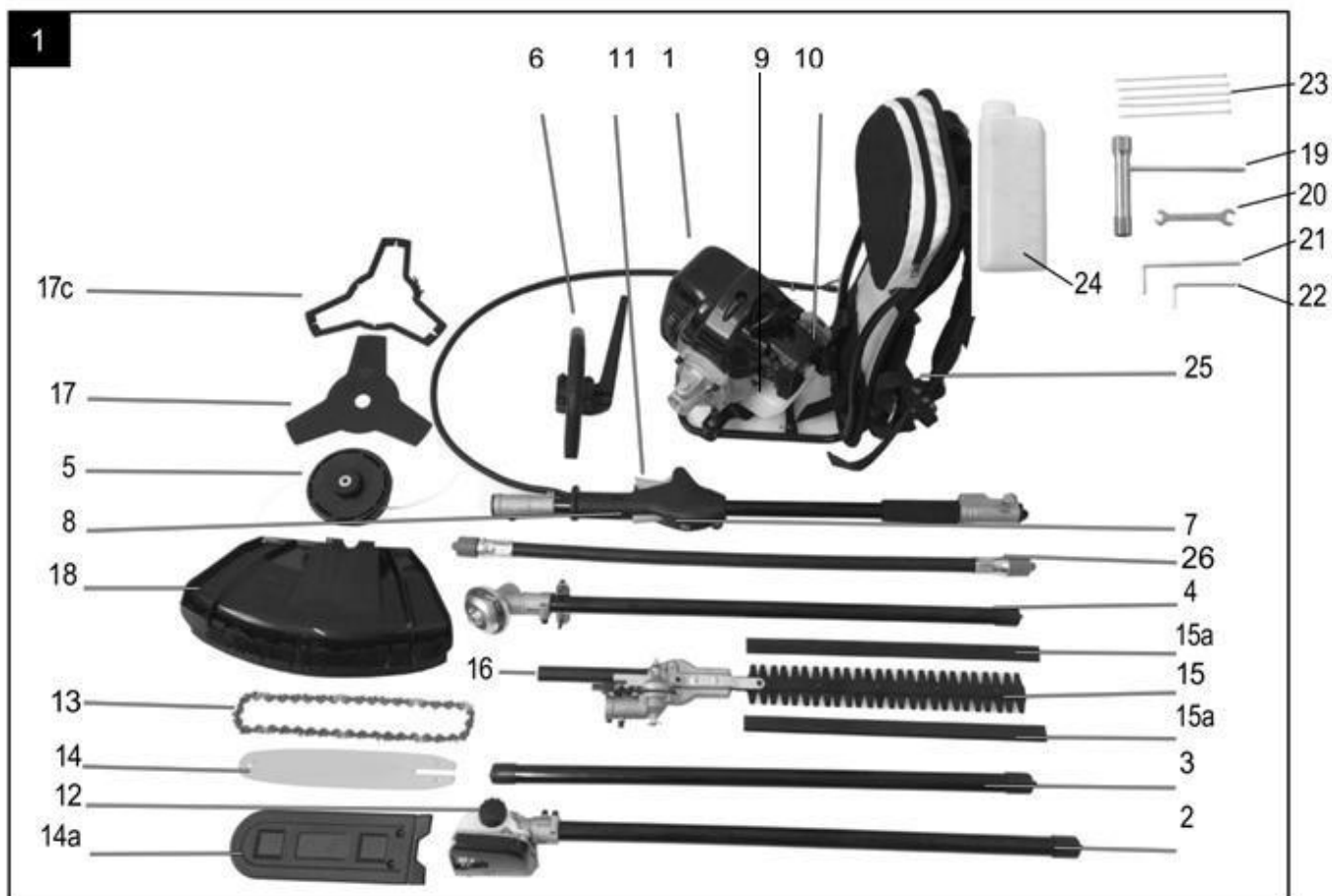

- |                                  |                                   |  |
|----------------------------------|-----------------------------------|--|
| 1) Motor drive unit              | 11) Throttle lever                | 18) Carter of protection for brushcutter and grass trimmer |
| 2) Pole saw                      | 12) Oil tank for chain saw        | 19) Spark plug wrench                                      |
| 3) Tube                          | 13) Saw chain                     | 20) Open-ended spanner (8 mm / 10 mm)                      |
| 4) Brushcutter/grass trimmerhead | 14) Chain saw blade               | 21) Allen key (size 4)                                     |
| 5) Nylon wire for grass trimmer  | 14a) Saw blade cover              | 22) Allen key (size 5)                                     |
| 6) Front handle                  | 15) Cutting unit hedge trimmer    | 23) 2 x cable ties   |
| 7) Stop Switch                   | 15a) Blade cover for hedgetrimmer | 24) Mixing bottle  |
| 8) Throttle lever "lock"         | 16) Adjustment lever              | 25) Backpack   |
| 9) Fuel tank                     | 17) Cutting blade                 | 26) Flexible shaft   |
| 10) Starter cable                | 17c) Blade cover                  |  |

## **Scope of delivery**

- Open the packaging and take out the equipment with care.
- Remove the packaging material and any packaging and/or transportation braces (if available).
- Check to see if all items are present.
- Inspect the equipment and accessories for transport damage. In case of complaints the supplier is to be informed immediately. Complaints received later will not be acknowledged.
- If possible, keep the packaging until the end of the guarantee period.
- Only use original parts for accessories as well as for wearing and spare parts. Spare parts are available from your specialized dealer.
- Specify our part numbers as well as the type and year of construction of the device in your orders.
- Important! Equipment and packaging material are not toys. Do not let children play with plastic bags, leaves, or small parts. There is a risk of swallowing and suffocation!

## **b. Technical data**

<b>Engine displacement</b>	65 cm <sup>3</sup>
<b>Maximum engine speed</b>	9500min <sup>-1</sup>
<b>Maximum power</b>	1,8 kW 7500/min
<b>Mass</b>	Pole pruner: 10,13 kg Grass trimmer/brushcutter: 9,81 kg Hedge trimmer: 10,59 kg
<b>Volume of fuel tank</b>	1200 cm <sup>3</sup>
<b>Grass trimmer</b>	Type: 2 lines (non-metallic flexible line) Cutting diameter: 430mm Cutting thickness: 2,4 mm
<b>Brush cutter</b>	Type: single piece (three teethes metal) Cutting diameter: 255mm
<b>Pole saw</b>	Saw chain: JL9D-3*39 Chain bar: 10"ZLA10-39-507P Length: 200mm
<b>Hedge trimmer</b>	Cutting wide: 24mm Cutting range: 390mm
<b>Maximum rotational frequency of the spindle</b>	9500min <sup>-1</sup>
<b>Engine type</b>	2-stroke engine
<b>Engine idle speed</b>	3000min <sup>-1</sup>
<b>Clutch engagement speed</b>	4860min <sup>-1</sup>
<b>Guaranteed sound power level</b>	111 dB(A)
<b>Sound power level</b>	<p><b><u>Pole pruner</u></b> LwA: 108 dB(A) K= 3 dB (A)</p> <p><b><u>Grass trimmer/Brushcutter</u></b> LpA: 108,3 dB (A) K= 3 dB (A)</p> <p><b><u>Hedge trimmer</u></b> LpA: 108,3 dB (A) K= 3 dB (A)</p>



<p><b>Sound pressure level</b></p>	<p><b><u>Pole pruner</u></b>  LpA: 101 dB(A)  K= 3 dB (A)</p> <p><b><u>Grass trimmer/Brushcutter</u></b>  LpA: 98 dB (A)  K= 3 dB (A)</p> <p><b><u>Hedge trimmer</u></b>  LpA: 98 dB (A)  K= 3 dB (A)</p>
<p><b>Vibration value</b></p>	<p><b><u>Pole pruner</u></b>  Max. 7,426 m/s<sup>2</sup>  Uncertainty: K=1,5m/s<sup>2</sup></p> <p><b><u>Grass trimmer and brushcutter</u></b></p> <p><u>Front handle</u>  Idling: 9,231m/s<sup>2</sup>  Racing: 9,623m/s<sup>2</sup></p> <p><u>Rear handle</u>  Idling: 9,237m/s<sup>2</sup>  Racing: 9,720m/s<sup>2</sup></p> <p>Uncertainty: K=1,5m/s<sup>2</sup></p> <p><b><u>Hedge trimmer</u></b></p> <p><u>Front handle</u>  Idling: 9,231m/s<sup>2</sup>  Racing: 9,623m/s<sup>2</sup></p> <p><u>Rear handle</u>  Idling: 9,237m/s<sup>2</sup>  Racing: 9,720m/s<sup>2</sup></p> <p>Uncertainty: K=1,5m/s<sup>2</sup></p>

### 3. ASSEMBLY

When assembling, put on protective gloves. Blades can be sharp.

#### a. Mounting the flexible shaft

- Pull the locking bolt out and fix the flexible shaft to the motor until the locking bolt locks in.



- Unscrew the air filter cover, screw the accelerator cable in as shown.



- Connect the ignition interruption cables.

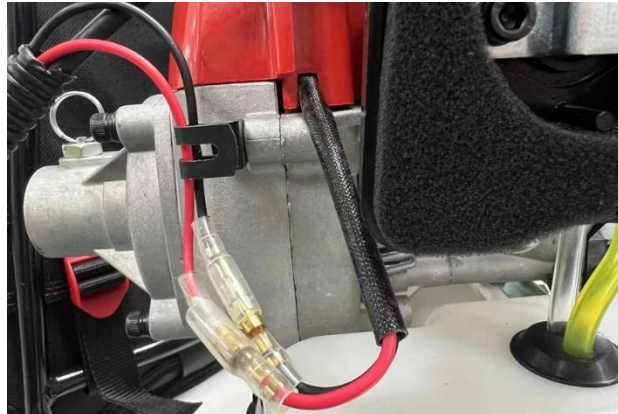

- Secure the air filter cover with a screw again.
- Remove the screw from the handle, insert the other side of the flexible shaft into the handle and use the screw to affix it to the handle.

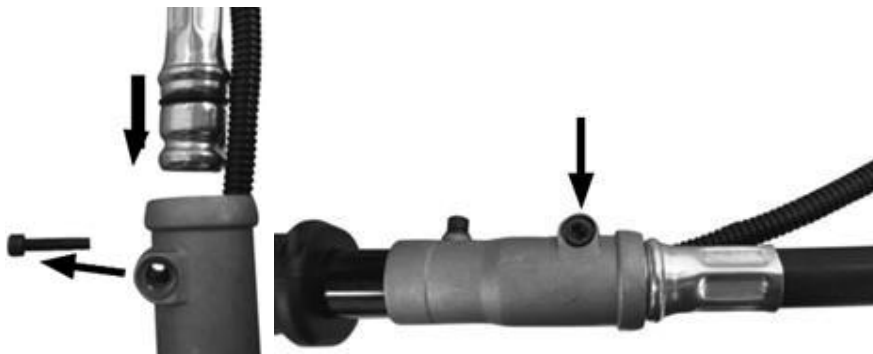

- Use cable ties to affix the accelerator cable to the flexible shaft.

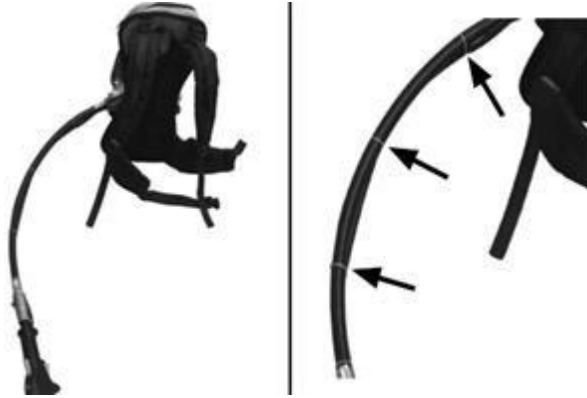

### **b. Mounting the tube**

- Pull out the locking pin (a) and press the lower part of the shaft (b) downward until the locking pin engages. The bolt (a) is in the right position when it is fully seated in the bore.
- Lastly, tighten the knob (d) securely.

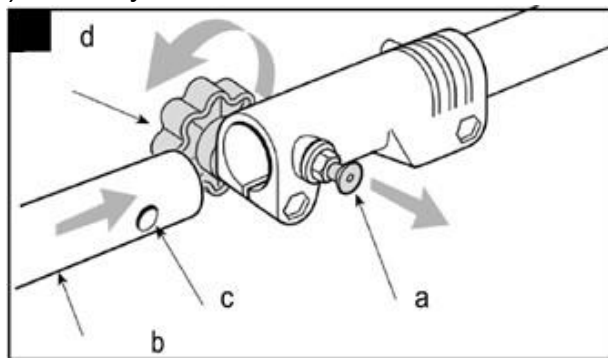

### **c. Assemble the handle**

- Install the front handle as shown on the image.
- Make sure that you align the pin with the hole. Tighten the screws only loosely before you have the most comfortable working position set to the risers.

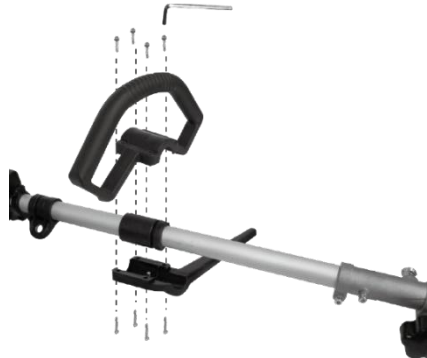

### **d. Assemble the carter of protection (grass trimmer and brush cutter)**

- On the brushcutter/grass trimmer tube, place the carter of protection on its support.
- Screw the carter of protection with the 2 screws provided.



**Warning!** For brushcutter and grass trimmer operation, never use the machine without the guard assembled!

**e. Blade for brushcutter**

- Align the two holes of the flange and the pin.
- Use a tool to hold the flange. Loosen the nut, use a wrench if necessary.
- Then remove the bell and the outer flange. Place the blade (17) on the tool, then replace the outerflange (17b) and the bell (17a).
- Tighten the nut.

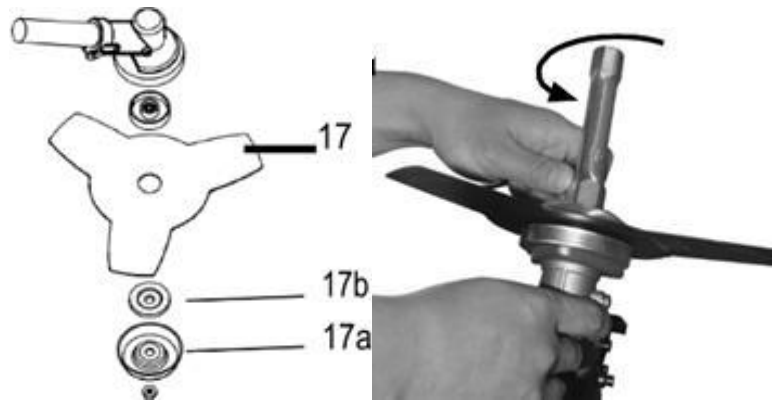

- To demount the blade, use screwdriver to hold flange and pin to release nut, the blade can be taking off.

**Warning!** Please make sure the cutting head has been assembled correctly before use!

**f. Cutting head for grass trimmer**

- Align the two holes of the flange and the pin.
- Use a tool to hold the flange. Loosen the nut, use a wrench if necessary.
- Then remove the bell and the outer flange. Place the cutting head on the tool and screw it on.

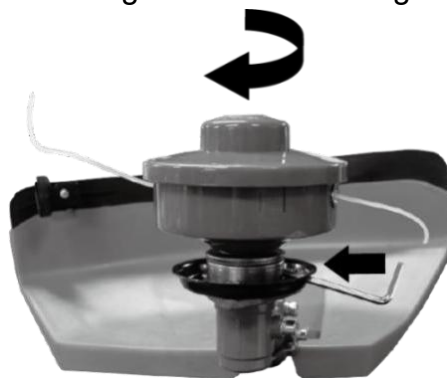

To demount the nylon cutting head, use a screwdriver to hold flange and then rotate the nylon cuttinghead clockwise.

**g. Mounting the hedge trimmer**

- Install the bar of the main unit. Make sure the locking pin is inserted into the bar hole.
- Fasten the bar by turning the nut counterclockwise.



### Adjusting the position

1. Press the release / safety plate to loosen and turn the unit to the desired position depending on the nature of the work to be performed.
2. Loosen the release / safety plate ensuring that the cutting accessories are securely in place and secured.

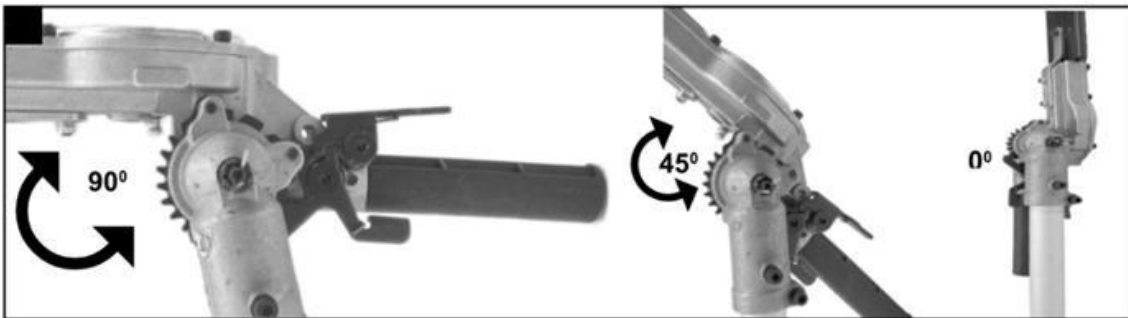

### Fitting the cutter bar and the chain

- Remove the chain wheel cover (J) by undoing the fastening nut (I). Lay the chain (F) as shown into the groove which runs around the cutter bar (E).
- Note the alignment of the chain teeth. Insert the cutter bar into the mount at the gear unit.
- Place the chain round the chain wheel (H). Make sure that the teeth of the chain engage securely in the chain wheel. The cutter bar must be hooked into the chain tensioning bolt (G).
- Fit the chain wheel cover.

Important! Do not fully tighten the fastening screw until after you have adjusted the chain tension.

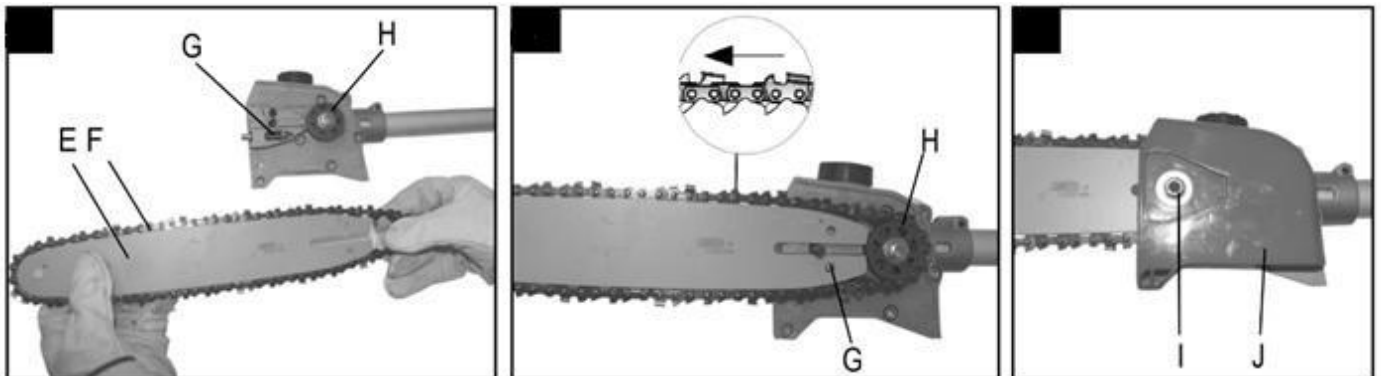

### h. Tensioning the chain

- Important! Always pull out the spark boot plug before performing any checks or adjustments.
- Undo the fastening screw (I) of the chain wheel cover by a few turns.
- Adjust the chain tension with the chain tensioning screw (K). Turning the screw clockwise increases the chain tension, turning it counterclockwise decreases the chain tension. The chain is correctly tensioned if it can be raised by around 2 mm in the middle of the cutter bar.
- Tighten the fixing screw of the chain wheel cover.

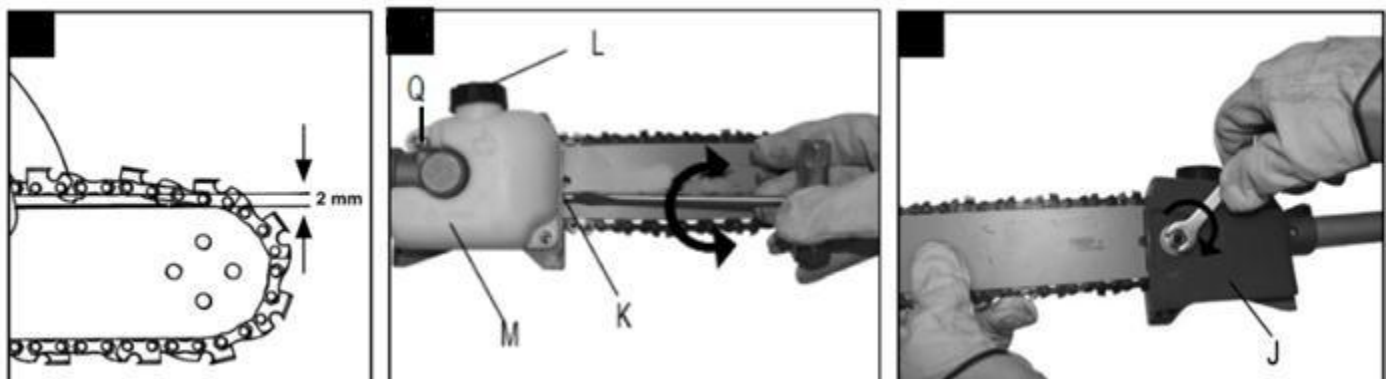

- Important! All the chain links must lie properly in the guide groove of the cutter bar.



### **i. Notes on tensioning the chain**

- The chain must be properly tensioned to ensure safe operation. When the saw chain can be raised by around 2 mm in the middle of the cutter bar, you know that the chain tension is ideal. During cutting, the temperature of the chain rises and its length changes. It is important therefore to check the chain tension at least every 10 minutes and to adjust it again as required. This applies to new saw chains. When you have finished working, slacken the chain again as it will shorten when it cools down. This will help to prevent damage to the chain.

### **j. Backpack**

- Install the backpack on the frame of the tool
- Wear the shoulder strap.
- Balance the machine when the tool is switched off.
- When standing in a normal working posture, the blade should touch the ground during normal working position.
- To fit the backpacks to your body size, adjust the straps at the carrying strap.
- **ATTENTION!** In an emergency, the safety button can be pressed from the harness. The machine then detaches immediately from the carrying strap and falls to the ground.

## **4. FILLING OIL TANK AND FUEL TANK**

Each time before use, check the following:

That there are no leaks in the fuel system.

That the equipment is in perfect condition and that the safety devices and cutting devices are complete. That all screws are securely fastened.

That all moving parts move smoothly.

### **a) Fuel and oil**

Use only a mixture of unleaded petrol and special 2-stroke engine oil. Mix the fuel mixture as indicated in the fuel mixing table.

**Important:** Do not use a fuel mixture which has been stored for longer than 90 days.

**Important:** Never use 2-stroke oil with a recommended mixing ratio of 100:1. The manufacturer's warranty will be voided in case of engine damage due to inadequate lubrication.

**Important:** Only use containers designed and approved for the purpose to transport and store fuel.

Pour the correct quantities of petrol and 2-stroke oil into the mixing bottle (see scale printed on the bottle). Then shake the bottle well.

Never use oil for 4-cycle engine or use water cooled 2-cycle engine. It can cause spark plug fouling, exhaust part blocking or piston ring sticking.

Mixed fuels, which have been left unused for a period of one month or more, may clog the carburetor or result in the engine failing to operate properly. Put remained fuel into an airtight container and keep it in the dark and cool room.

### **b) Fuel mixing table**

Mixing procedure: 40 parts petrol/1-part oil Example:

1 liter of petrol: 0,025 L 2-stroke oil 5 liters of petrol: 0,125 L 2-stroke oil

### **Warning!**

Take care of the emission of exhaust gases. Always shut off engine before fueling. Never add fuel to a machine with a running or hot engine. Take care of fire!

Only ever refuel the tool outdoors or in sufficiently ventilated rooms. Make sure not to spill fuel or chain oil into the soil (environmental protection). Use a proper base.

### c) **Filling with fuel**

Danger of injury! Fuel is explosive!

Turn the motor off and let the machine cool down. Wear safety gloves. Avoid contact with skin and eyes.

Make sure you observe the “Safety Instructions” paragraph.

- Only ever refuel the tool outdoors or in sufficiently ventilated rooms.
- Clean around the filling area. Contaminants in the tank will cause operating problems.
- Before refueling, shake the container with the fuel mixture.
- Carefully open the fuel filler cap so that potential pressure can be released.
- Carefully pour in the fuel mixture to the lower edge of the filler.
- Close the fuel filler cap. Ensure the fuel filler cap closes tightly.
- Clean the fuel filler cap and the area around it.
- Check the tank and the fuel line for leaks.
- Before starting the motor, remove yourself from the fueling place by at least three meters.

### d) **Draining fuel**

Only ever empty the tank outdoors or in well-ventilated rooms. Make sure not to spill fuel or chain oil into the soil (environmental protection). Use a proper base.

- Hold a collection container beneath the fuel drain bolt.
- Unscrew the tank cap and remove it.
- Allow the fuel to run out completely.
- Screw the tank cap on firmly by hand



## 5. OPERATION

- Do not start the unit until it has been completely assembled.



Danger of injury!

- Only start the petrol multi garden tool if an attachment is connected! Remove the appropriate transportation protection and inspect the unit in good working condition. Never use a damaged, poorly adjusted or serviced or not completely and securely assembled device.
- Check before use!
- Check the safe condition of the device
- Check the device for leaks.
- Check the device for visual defects.
- Check that all parts of the device have been securely fitted.
- Check that all safety devices are in proper condition.

### a) **Start on the unit**

- 1) Turn the engine switch to the ON position.
- 2) Put the choke lever on the START position  (closed position).

3) Press the fuel pump (b) 10 times.

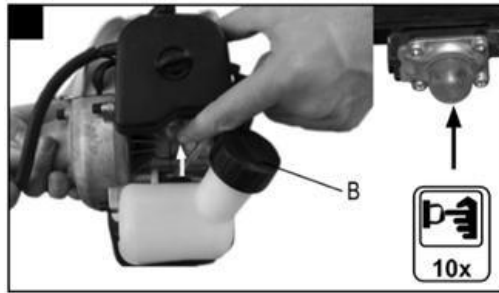

4) Pull the recoil starter handle 3-5 times to start the engine.

5) Wait a while adjust the choke lever to the RUN position  (open position).

6) First press the lock off lever (8) and then switch the throttle lever (11) on, the machine will be working.

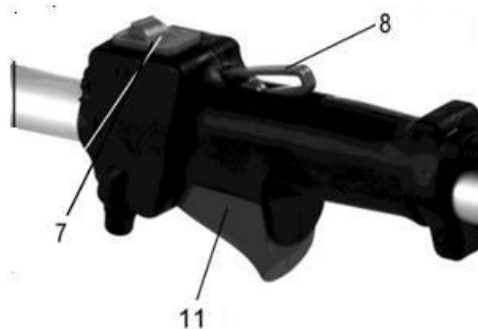

7) If meet any problems, press the engine switch to off position, the machine will stop running. If need stop cutting head working, release the throttle lever (11).

8) In an emergency, the safety button can be pressed from the harness. The machine then detaches immediately from the carrying strap and falls to the ground.

9) If the machine is hot, the throttle level can be adjusted to ON position directly when restart the machine.

**Note:** Always pull the starter cord out in a straight line. If it is pulled out at an angle, then friction will occur on the eyelet. As a result of this friction, the cable will become frayed and will wear away faster. Always hold the starter handle when the cable retracts.

Never allow the cable to snap back when it has been pulled out.

Note: Do not start the motor in tall grass.

**Attention:** When the engine has been switched off, the cutting unit continues running for several seconds therefore do not touch the cutting unit until it has come to a standstill!

### b) Working with brush cutter

- When you work with the petrol brush cutter for the first time, familiarize yourself with the operation and control of the petrol cutting blade without running engine.
- The design of the petrol brush cutter allows for operation only at the right side of the user's body.
- Keep the petrol brush cutter firmly with both hands on the handles.
- Hold the operating handle with your right hand and the handle on the shaft with your left hand.
- Always make sure that the cutting tool continues to rotate briefly after the throttle has been released.
- Always work with high speed so you have the best cutting results.
- Move the device with a uniform curved movement from left to right and back again.
- Attention: Always move the device back into the original position before cutting the next path.
- Caution: Always be extra careful when working in difficult terrain and slopes. Cut tall grass gradually so as not to overload the unit.
- Always wear safety glasses and hearing protection and a safety helmet.
- Use the cutting blade to comb through brushwood, rank growth, young tree populations (trunk



diameter of maximum 2 cm), and high grass.

- While using metal cutting tools, there is generally a risk of recoil, when the tool hits a solid obstacle (stones, trees, branches, etc.). Thereby, the tool is hurled backwards against the rotating direction.
- To cut rank growth and brushwood, you “immerse” the cutting blade from the top.
- Attention! The cutting unit is still running! Do not stop the cutting unit with your hand.
- Keep the cutting unit away from feet.
- **CAUTION:** Be especially careful during the operation, because the further away the cutting tool is from the ground, higher is the risk of projections.

### c) Working with the grass trimmer

- Use the plastic line cassette for a clean cut also at uneven edges, fencing posts, and trees.
- Carefully advance the trimming line to an obstacle and use the tip of the line to cut around the obstacle. When the trimming line meets stones, trees, and walls, the line wears out or breaks off ahead of time.
- Never replace the nylon line with a metal wire. Risk of injuries!

#### Automatic thread trimming

- The petrol cutting blade is delivered with a filled line cassette.
- This line will wear out during work. To feed new line, forcefully press the head of the line cassette onto the ground while the engine is running at working speed. The line is automatically fed due to centrifugal force. The knife at the line guard will shorten the trimming line to the correct length.

### d) Working with hedge trimmer

- The hedge trimmer may be used only for cutting hedges, bushes and shrubs
- Hold the hedge trimmer with both hands on a safe distance from the body.
- Due to its double-sided knives the hedge trimmer can be guided forward and backward or by oscillating movements from one to another side.
- At first cut the sides of the hedge and then the up- per edge.
- Cut the hedge from the bottom up.
- Cut the hedge in trapezium shape.
- Remove unconditionally any foreign objects out of the hedge (e.g. wires) as these can damage the knives of the hedge trimmer.
- **Attention!** The blades are still running! Do not stop the blades with your hand.

#### Angle adjustment

- By swiveling the cutter head, the hedge trimmer can be adjusted to the working conditions.
- Warning! Adjust the angle only when the motor has been turned off.
- Push both levers down and put the cutter head in the required position.
- Release both levers until they click into place in the notch.
- Before use, check that the adjustment levers have locked into place properly.
- Oil the blades and the angle adjustment each time before starting work, with environmentally friendly lubricant.
- Regularly oil the blades during working hours as well. Warning! Oil the tool only when the motor has been turned off.
- Caution: Incorrect use and misuse can damage the bush cutter and cause severe injuries because of pieces hurled away.
- To minimize the risk of accidents by use of the cutting lade, take note of following points.

## **e) Working with pole saw**

### **Oiling of the chain and bar**

It is recommended to use chain oil sold in specialized stores.

- Remove the oil tank cap.
- Fill the chain oil tank to 80% with chain oil.
- Close Oil tank cap.
- Oil tank capacity: 140 ml

### **Oil Supply Control**

- Always make sure that the automatic oil system is working properly. Always ensure the oil tank is full. During sawing work, the guide and the chain must always be sufficiently oiled to reduce friction with the chain bar.
- The chain bar and the chain must never be without oil. If you operate the chain dry or with too little oil, the cutting performance will decrease, the service life of the chain bar will reduce, the chain will become blunt quickly and the guide will wear rapidly owing to overheating. You can detect a lack of oil from smoke development or the guide changing color.
- To check the chain lubrication, keep the chain on a piece of paper and give full throttle for a few seconds. On the paper the quantity of oil can be checked. The saw chain must always throw off a little oil. After a few seconds, a slight oil trace must be visible.

### **Automatic chain lubrication**

You can reduce or increase the quantity of oil using the screw.

- Clockwise - oil quantity is reduced (-)
- Anti-clockwise - oil quantity is increased (+)

### **Precautions for saw procedure**

- Never stand under the branch you want to saw. Use special caution when working with branches under tension and splintering wood. Possible risk of injury caused by falling branches and catapulting pieces of wood. In general, it is recommended to set the pruning saw at an angle of 60 ° to the road.
- Keep both hands well with the device during the cutting process and pay you up to an equilibrium position and a good level.
- Never try to use your tool with one hand. The loss of control of your tool can cause serious injury or death. Never work on a ladder, a tree branch, or other unstable surfaces.
- Never cut with the upper edge or the tip of the cutter bar.
- Make sure that the chain tension is always correctly adjusted.
- Practice for guiding the device slight pressure, but you do not overload the motor.
- Clear the work area before cutting interfering branches and undergrowth. Then you create a retreat area, far from the spot where the cut branches fall on and remove any obstacles there. Keep the work area clean, remove the cut branches immediately. Pay attention to your point, wind direction and the possible direction of fall of the branches. Be prepared that fallen branches can strike back. Place all other tools and equipment at a safe distance from the branches to be cut, but not in the retreat area.

### **Always observe the condition of the tree**

- Look for rot in the roots and branches. If they are rotten inside, they can break off and fall down unexpectedly during cutting.
- You could also attend by fractured and dead branches out. For very thick or heavy branches you first make a small incision below the branch before you work from the top down to avoid chipping.

### **Basic cutting technique**

- Heavy branches break off easily when sawing. They tear long strips of bark away from the trunk, which damages the tree sustainably. The following section technique can significantly reduce this risk:

- Saw the first branch about 10 cm from the trunk.
- Put in about 15 cm from the base of the top of a further section
- Saw until the branch breaks. The risk of injury on the trunk is no.
- Finally, remove with a clean cut from the top of the trunk along the remaining.

### **Hazards by reactive forces**

- Reactive forces occur during operation of the saw chain. The forces which are applied to the wood are against the operator. They occur when the moving chain meets a fixed object such as a branch or is pinched. These forces can lead to a loss of control and injury.

- Understanding the origin of these forces can help you to avoid the scare and the loss of control. This saw is designed to make the return effects are not as noticeable as with traditional chain saws.

- Always keep a firm grip and a good level to maintain control of the tool in doubt.
- The most common effects are: kickback, withdrawal, recoil.

### **Kickback**

- The setback can occur when the moving saw chain meets at the upper quarter of the guide rail on a solid object or is pinched.

- The cutting force exerted on the chain from the saw, a rotational force in the opposite direction to the chain travel. This leads to an upward movement of the guide rail.

### **Avoid kickback**

- The best protection is to avoid situations that lead to setbacks.
- Keep the position of the upper guide rail always in mind.
- Never meet an object. Be especially careful near wire fences and cutting small, hard knots, in which the chain can easily pinch.
- Cut only one branch at a time.

### **Withdrawal**

- The withdrawal occurs when the chain on the under- side of the bar suddenly stuck because it is jammed or encounters a foreign object in the wood.

- The chain then pulls the saw forward. The withdrawal often happens when the chain is not running at full speed when in contact with the wood.

### **Avoid withdrawal**

- Be aware of the forces and situations that can lead to jamming of the chain on the underside of the bar.
- Always start with running at full speed chain to cut.

### **Recoil**

- The recoil occurs when the chain on top of rail suddenly stuck because it is jammed or encounters a foreign object in the wood. The chain can jerkily hold the saw against the operator. Rebounds happen often if the top rail is used for cutting.

### **Avoid recoil**

- Be aware of the forces and situations that can lead to jamming of the chain on top of rail.
- Do not cut more than one branch at a time.
- Do not tilt the rail to the side when you pull them out of a cutting gap, since the chain could get caught otherwise.

## 6. MAINTENANCE

**WARNING:** Always wear protective gloves when working on or around cutting tools.

- For non-use, transport or storage always attach the transport guard to all cutting tools.
- Before performing any maintenance or cleaning work, always turn off the engine and pull out the spark boot plug.
- Do not spray the unit with water. It damages the engine.
- Clean the unit with a cloth, hand brush, etc.
- Use a moist piece of cloth to clean the plastic parts. Do not use any cleaning agents, solvents, or sharp objects.
- During work, wet grass and weed wraps around the drive shaft below the cutting guard for technical reasons. Remove this, otherwise the engine will overheat because of too much friction.

### Regular checks

- Keep in mind that following specifications relate to normal usage. Owing to circumstances (longer periods of daily work, severe dust exposure, etc.), the specified intervals will become correspondingly shorter.
- Before starting work, after tank filling, after impact or dropping:
  - Check the cutting tools for secure seating, general visual check for cracks and damage.
  - Immediately replace damaged or blunt cutting tools, even in the event of minor hairline cracks.
  - Sharpen cutting tools.
- Weekly inspection: Lubrication of gear.
- If necessary: Retighten accessible fastening screws and nuts. You will avoid excessive wear and tear and damages of the tool when you follow the instructions in this manual.

### Replacing the line spool/cutting line

- Pull off the line guard cap from the line spool by forcefully pressing between the retaining plates.
- Remove the spool with line remaining and the compression spring.
- Remove the used-up spool.
- Take the new line spool and pull out 10 cm at both lines each.
- Now, place the line spool on the tapered spring, and guide both lines each through the round metal lugs at the line spool housing.
- Then place the spool cover on the new line spool. Turn it so that the plates of the spool cover are pushed with the springs in the line spool housing.
- Now, press the spool cover together with the line spool, until it engages in the line spool housing.
- The knife in the protective hood shortens the trimming line to the correct length, when the engine starts again.

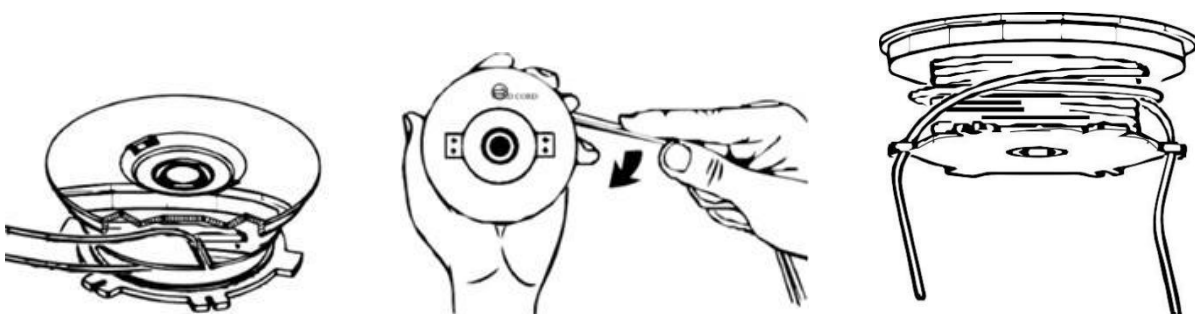
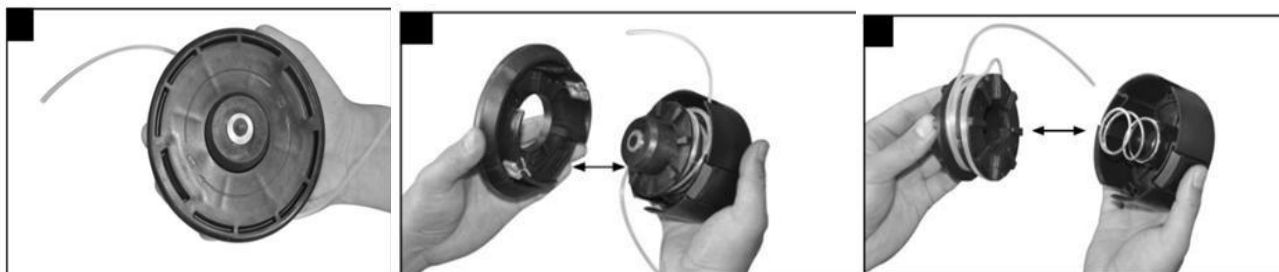

### **Grinding the safety hood blade**

- The safety hood blade can become blunt over time.
- When you notice this, undo the screw holding the safety hood blade on the safety hood.
- Clamp the blade in a vice.
- Sharpen the blade with a flat file and make sure that the angle of the cutting edge is not altered in the process. File in one direction only.
- Important! Install the cutting knife again
- Replace and sharpen the cutting blade at the end of the mowing season.

### **Grinding the cutting blade**

If the blades become slightly dull, you can sharpen them yourself.

- Fasten the blade in a vice.
- Grind all 3 cutting unit blades using a flat file and make sure to maintain the angle of the cutting edge. (~25°) Only file in one direction.
- Replace the blades after sharpening them five times at the latest.
- Replace and sharpen the cutting blade at the end of the mowing season. Always sharpen the cutting blade or, if required, replace the cutting blade with a new one.
- Unbalanced blades will cause the brush cutter to vibrate violently-risk of accident!

### **Lubricate angle transmission**

Lubricate with lithium-based grease. Remove the screw and put in the grease, turning the shaft manually until grease emerges, then replace the screw.

Attention! Fill only a small amount of grease. Do not overfill.

### **Change and clean the spark plug**

- Check the spark plug air gap at least once a year or when the engine starts poorly. The correct gap is 0.25"/0.63 mm.
- Wait until the engine has cooled down completely.
- Pull the spark plug cap off the spark plug, and use the supplied spark plug wrench to remove the spark plug by turning.
- When the electrode is severely worn out or reveals a strong incrustation, the spark plug must be re- placed with an equivalent plug.
- A strong incrustation of the spark plug can be caused by: Amount of oil is too high in the gasoline mix, poor oil quality, old gasoline mix, or plugged up air filter.
- Screw the spark plug by hand completely into the thread. (Avoid jamming it)
- Use the supplied spark plug wrench to tighten the spark plug.
- When using a torque wrench, the tightening torque is 12-15 Nm.
- Plug the spark plug socket correctly on the plug.

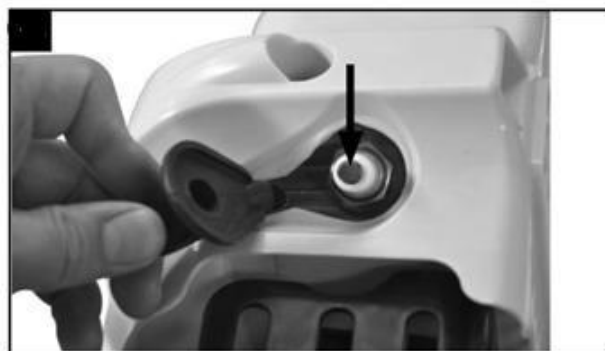

### **Clean the air filter**

Soiled air filters reduce the engine power by supplying too little air to the carburetor. Dust and pollen plug up the pores of the filter made of foamed plastic. Regular checks are therefore essential.

- Unscrew the knob of the cover of the air filter.
- Remove the filter element and wash it in warm soap water, rinse and allow drying naturally.

**Important:** Never clean the air filter with petrol or inflammable solvents.

In order not to shorten the service life of the engine a damaged air filter must be replaced at once.

**Warning!** Never run the engine without the air filter element installed.

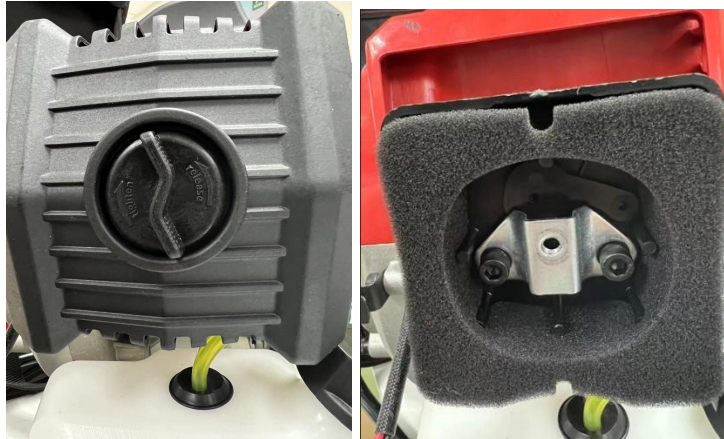

### **Care of the guide rail**

Turn the rail around every time you have the chain sharpened or replaced. This will avoid a one-sided wear of the rail, especially at the top and bottom.

Regularly clean:

- the opening for the oil supply
- the oil passage
- the raceway groove of the rail

### **Servicing and sharpening of saw chain**

The correct sharpened chain.

A properly sharpened chain goes way through the wood and it requires very little pressure. Do not work with a dull or damaged chain. It increases physical exertion, increase the vibrations and leads to unsatisfactory results and higher wear.

- Check and clean the chain.
- Replace damaged or worn parts with matching spare parts they are in the shape and size of the original parts as necessary.
- Sharpening a chain should be performed only by experienced users!
- If the chain is not properly sharpened or the depth is too small, there is a higher risk of reversion effects and resulting injuries!
- It is best to remove the chain from the rail and then sharpen.
- Select the appropriate tools for the chain pitch sharpening tool. The chain pitch (for example 3/8") is highlighted in the depth of each blade.
- Use only special files for chain saws! Other files have the wrong shape and the wrong cut.
- Select the file according to the diameter of your chain pitch. Make sure to observe the following angle when sharpening the chain diameter.

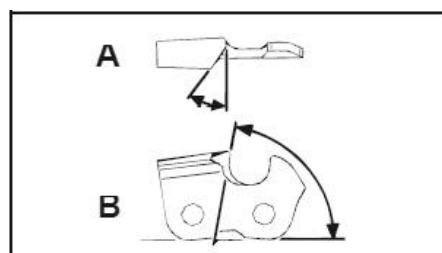

A = filing angle

B = the angle of the side plate

The angle must also be maintained for all knives. For irregular angles, the chain is run irregularly, wear quickly and break down prematurely.

Since these requirements can only be met with sufficient and regular exercise:

- A File Holder must be used when sharpening the saw chain by hand. The correct filing angle marked on it.
- Hold the file horizontally (at a right angle to the guide rail) and file according to the angle mark on the file holder. Support the file holder on the top plate and depth gauge.
- File down. The knife is always from the inside to the outside
- The file sharpens only in forward motion. Lift it off in the backward motion.
- Do not touch the dynamic links with the file.
- Turn the file regularly continue to avoid a one-sided wear.

All knives must have the same length, otherwise they will also vary. As a result, the chain is irregular and it increases the risk of going broke.

### **Lubricate the drive, pole pruner**

Lubricate the drive every 10 to 20 operating hours.

- Apply the grease gun to the grease nipple Fig .54 (Q).
- Squeeze some grease into it.

**Attention!** Fill only a small amount of grease. Do not overfill.

### **Check the hedge trimmer for obvious faults such as**

- Loose attachments
- Worn or damaged components
- Bent, broken or damaged cutting tools
- Correctly attached and working covers and safety devices
- Wear, in particular, cutting tool play

Immediately replace damaged or blunt cutting tools, even in the event of minor damage.

### **Oiling the gears**

Oil the gears every 10 to 20 operating hours.

- Position the grease gun at the lubricating nipples.
- Insert some grease.
- Attention! Fill only a small amount of grease. Do not overfill
- Oil the cutting tools and the angle adjustment with environmentally friendly lubricant.

### **Setting the idle speed**

If the cutting tool is still moving when the device is in idle, change the idle speed.

- Let the motor warm up for 3-5 minutes (not at high speed!).
- Turn the adjusting screw (S):
  - Clockwise: The idle speed will increase (+)
  - anti-clockwise: The idle speed will decrease (-)The idle speed is 3000 min<sup>-1</sup>.

Contact the manufacturer if the cutting tool still continues to move in idle. Do not continue working with the tool!

### **Wear Parts**

Even when used in the intended way, some components are subject to normal wear. They must be replaced depending on the kind of duration of usage. These parts include, among others, the cutting tool and the retaining disk.

Warning! Use only original manufacturer 's replacement parts, accessories and attachments. Failure to do so can cause poor performance, possible injury and may void your warranty.

Due to security reasons please see to it that the equipment is sent back free of oil and gas!

## 7. STORAGE

### a) Cleaning

- Keep handles free of oil, so you always have a secure hold.
- Clean the equipment as required with a damp cloth and, if necessary, mild washing up liquid.

#### **Important!**

- Always pull out the spark boot plug each time before carrying out any cleaning.
- Never immerse the equipment in water or other liquids in order to clean it.
- Store the petrol multi garden tool in a safe and dry place out of the reach of children.

### b) Storage

Important: Never put the equipment into storage for longer than 30 days without carrying out the following steps.

Storing the equipment

If you intend to store the equipment for longer than 30 days, the equipment must be prepared accordingly. Otherwise the fuel remaining in the carburetor will evaporate and leave a rubbery sediment. This can cause problems when starting up the equipment and may require expensive repairs.

- Slowly remove the fuel tank cap to release any pressure that may have formed in the tank. Carefully empty the tank. Only empty the tank outdoors or in well-ventilated rooms. Make sure that no fuel or chain oil is released into the soil (environmental protection). Use a suitable surface.
- To remove the fuel from the carburetor, start the engine and let it run until the equipment stops.
- Leave the engine to cool (approx. 5 minutes).
- Remove the spark plug (see section 10 Change and clean the spark plug).
- Add one teaspoon of 2-stroke engine oil into the combustion chamber. Slowly pull the starter cord several times to apply a layer of oil to all internal components. Fit the spark plug again.

**Note:** Store the equipment in a dry place and far away from possible ignition sources such as an oven, a gas fired hot water boiler, a gas fired dryer, etc.

### c) Transport

To transport the machine, empty the petrol tank. Clean coarse dirt off the equipment with a brush or handbrush.

Always attach the transport guard to all cutting tools.

In order to prevent damage and injury, secure the tool against tipping over and sliding when transporting it in vehicles.

## 8. DISPOSAL AND RECYCLING

The equipment is supplied in packaging to prevent it from being damaged in transit. The raw materials in this packaging can be reused or recycled. The equipment and its accessories are made of various types of material, such as metal and plastic. Defective components must be disposed of as special waste. Ask your dealer or your local council.

## 9. TROUBLESHOOTING

The table below contains a list of fault symptoms and explains what you can do to remedy the problem if your equipment fails to work properly. If the problem persists after working through the list, please contact your nearest service workshop.



Fault	Possible cause	Remedy
Machine does not start.	<ul style="list-style-type: none"> <li>• Air filter is contaminated.</li> <li>• Fuel filter is blocked.</li> <li>• Lack of fuel supply.</li> <li>• Fault in the fuel line.</li> <li>• Starting device is faulty.</li> <li>• Engine stalled.</li> <li>• Spark plug cap not attached.</li> <li>• No spark.</li> <li>• Engine faulty.</li> <li>• Carburetor faulty</li> </ul>	<ul style="list-style-type: none"> <li>• Clean/replace the air filter.</li> <li>• Clean or renew the fuel filter.</li> <li>• Re-fuel.</li> <li>• Check the fuel line for kinks or damage.</li> <li>• Contact the service centre.</li> <li>• Remove the spark plug, clean and dry it; then pull the starter rope several times; re-fix the spark plug.</li> <li>• Check the correct position of the spark plug cap.</li> <li>• Clean the spark plug or replace it, if applicable.</li> <li>• Check the ignition cable for damage.</li> <li>• Contact the service centre.</li> <li>• Contact the service centre.</li> </ul>
Machine starts but stops again.	<ul style="list-style-type: none"> <li>• Wrong carburetor setting (idle speed).</li> </ul>	<ul style="list-style-type: none"> <li>• Contact the service centre.</li> </ul>
Engine starts but the cutting tool stops.	<ul style="list-style-type: none"> <li>• Cutting tool blocked.</li> <li>• Internal fault (drive shaft, gearbox).</li> <li>• Clutch faulty.</li> </ul>	<ul style="list-style-type: none"> <li>• Turn off engine and remove object.</li> <li>• Contact the service centre.</li> <li>• Contact the service centre.</li> </ul>
Machine works with interruptions (sputtering).	<ul style="list-style-type: none"> <li>• Carburetor set up incorrectly.</li> <li>• Spark plug is sooty.</li> <li>• On/off switch faulty.</li> </ul>	<ul style="list-style-type: none"> <li>• Contact the service centre.</li> <li>• Clean the spark plug or replace it.</li> <li>• Contact the service centre.</li> </ul>
Smoke is generated.	<ul style="list-style-type: none"> <li>• Wrong fuel mix.</li> <li>• Carburetor set up incorrectly.</li> </ul>	<ul style="list-style-type: none"> <li>• Use two-stroke mixture at a ratio of 40:1.</li> <li>• Contact the service centre.</li> </ul>
Machine does not work at full power.	<ul style="list-style-type: none"> <li>• Machine is overloaded.</li> <li>• Air filter is contaminated.</li> <li>• Carburetor set up incorrectly.</li> <li>• Silencer is blocked.</li> </ul>	<ul style="list-style-type: none"> <li>• Do not use force during mowing/trimming.</li> <li>• Clean the air filter or replace it.</li> <li>• Contact the service centre.</li> <li>• Check the exhaust.</li> </ul>
Brush cutter does not work at full power.	<ul style="list-style-type: none"> <li>• Blades are blunt or damaged.</li> <li>• Cut material is too high (machine overload).</li> </ul>	<ul style="list-style-type: none"> <li>• Sharpen or replace blades.</li> <li>• Cut the grass in phases.</li> </ul>
Grass trimmer does not work at full power.	<ul style="list-style-type: none"> <li>• Cutting line too short or damaged.</li> <li>• Machine is overloaded because the grass is too high.</li> </ul>	<ul style="list-style-type: none"> <li>• Feed more cutting line through or replace it.</li> <li>• Cut the grass in phases.</li> </ul>
Cutting line cannot be fed through.	<ul style="list-style-type: none"> <li>• Spool empty.</li> </ul>	<ul style="list-style-type: none"> <li>• Replace spool.</li> </ul>
Pole saw does not saw, it plucks or vibrates.	<ul style="list-style-type: none"> <li>● Chain tension too high.</li> <li>● Chain blunt.</li> <li>● Chain attached incorrectly.</li> <li>● Chain worn.</li> </ul>	<ul style="list-style-type: none"> <li>● Check and reset chain tension.</li> <li>● Have the chain sharpened or replace it.</li> <li>● Re-attach the chain.</li> <li>● Replace the chain.</li> </ul>
Saw chain becomes hot or saw chain lubrication does not work.	<ul style="list-style-type: none"> <li>● No oil in the tank.</li> <li>● Oil line blocked.</li> <li>● Chain tension too high.</li> <li>● Chain blunt.</li> </ul>	<ul style="list-style-type: none"> <li>● Refill oil.</li> <li>● Clean the oil line.</li> <li>● Set the chain tension.</li> <li>● Have the chain sharpened or replace it.</li> </ul>

# 10. DECLARATION OF CONFORMITY



BUILDER SAS

32 rue Aristide Bergès - Z.I. du Casque - 31270 Cugnaux - France

Tel: +33 (0)5.34.502.502 Fax: +33 (0)5.34.502.503

Declares that the machine:  
PETROL MULTI-FUNCTION  
HCOMBID65

Serial No: 20221202616- 20221204735

Have been designed in compliance with the following standards:

EN ISO 11680-1 : 2021 ; EN ISO 11680-2 :2021 ;

EN ISO 11806-2 : 2022 ; EN ISO 11806-2 :2022

EN ISO 10517-1:2019; EN ISO 14982: 2009

And in accordance with the following directives:

Directive Machine 2006/42/EC

Directive EMC 2014/30/EU

Emission directive (EU) 2016/1628

Noise Directive 2000/14/EC Annex V & Directive 2005/88/EC

<b>Guaranteed sound power level</b>	111 dB(A)
<b>Sound power level</b>	<b><u>Pole pruner</u></b> LwA: 108 dB(A) K= 3 dB (A)  <b><u>Grass trimmer/Brushcutter</u></b> LpA: 108,3 dB (A) K= 3 dB (A)  <b><u>Hedge trimmer</u></b> LpA: 108,3 dB (A) K= 3 dB (A)

Responsible of the Technical file: M. Olivier Patriarca

Philippe MARIE / PDG

Cugnaux, 18/09/2022

# 11. WARRANTY

# HYUNDAI

## WARRANTY

The manufacturer guarantees the product against defects in material and workmanship for a period of 2 years from the date of the original purchase. The warranty only applies if the product is for household use. The warranty does not cover breakdowns due to normal wear and tear.

The manufacturer agrees to replace parts identified as defective by the designated distributor. The manufacturer does not accept responsibility for the replacement of the machine, in whole or in part, and/or ensuing damage.

### The warranty does not cover breakdowns due to:

- insufficient maintenance.
- abnormal assembly, adjustment or operations of the product.
- parts subject to normal wear and tear.

### The warranty does not extend to:

- shipping and packaging costs.
- using the tool for a purpose other than that for which it was designed.
- the use and maintenance of the machine done in a manner not described in the user manual.

Due to our policy of continuous product improvement, we reserve the right to alter or change specifications without notice. Consequently, the product may be different from the information contained therein, but a modification will be undertaken without notice if it is recognized as an improvement of the preceding characteristic.

### READ THE MANUAL CAREFULLY BEFORE USING THE MACHINE.

When ordering spare parts, please indicate the part number or code, you can find this in the spare parts list in this manual. Keep the purchase receipt; without it, the warranty is invalid. To help you with your product, we invite you to contact us by phone or via our website:

- **+33 (0)9.70.75.30.30**
- **<https://services.swap-europe.com/contact>**

You must create a "ticket" via the web platform.

- Register or create your account.
- Indicate the reference of the tool.
- Choose the subject of your request.
- Describe your problem.
- Attach these files: invoice or sales receipt, photo of the identification plate (serial number), photo of the part you need (for example: pins on the transformer plug which are broken).



# 12. PRODUCT FAILURE

## WHAT TO DO IF MY MACHINE BREAKS DOWN?

### **If you bought your product in a store:**

- a) Empty the fuel tank if your product has one.
- b) Make sure that your machine is complete with all accessories supplied, and clean! If this is not the case, the repairer will refuse the machine.

Go to the store with the complete machine and with the receipt or invoice.

### **If you bought your product on a website:**

- a) Empty the fuel tank if your product has one..
- b) Make sure that your machine is complete with all accessories supplied, and clean! If this is not the case, the repairer will refuse the machine.
- c) Create a SWAP-Europe service ticket on the site: <https://services.swap-europe.com> When making the request on SWAP-Europe, you must attach the invoice and the photo of the nameplate (serial number).
- d) Contact the repair station to make sure it is available before dropping off the machine.

Go to the repair station with the complete machine packed, accompanied by the purchase invoice and the station support sheet downloadable after the service request is completed on the SWAP-Europe site

For machines with engine failure from manufacturers BRIGGS & STRATTON, HONDA and RATO, please refer to the following instructions.

Repairs will be done by approved engine manufacturers of these manufacturers, see their site:

- <http://www.briggsandstratton.com/eu/fr>
- <http://www.honda-engines-eu.com/fr/service-network-page;jsessionid=5EE8456CF39CD572AA2AEEDFD290CDAE>
- <https://www.rato-europe.com/it/service-network>

**Please keep your original packaging to allow for after-sales service returns or pack your machine with a similar cardboard box of the same dimensions.**

**For any question concerning our after-sales service you can make a request on our website <https://services.swap-europe.com>**

**Our hotline remains available at +33 (9) 70 75 30 30.**



# 13. WARRANTY EXCLUSIONS

## THE WARRANTY DOES NOT COVER:

- Start-up and setting up of the product.
- Damage resulting from normal wear and tear of the product.
- Damage resulting from improper use of the product.
- Damage resulting from assembly or start-up not in accordance with the user manual.
- Breakdowns related to carburetion beyond 90 days and fouling of carburetors.
- Periodic and standard maintenance events.
- Actions of modification and dismantling that directly void the warranty.
- Products whose original authentication marking (brand, serial number) has been degraded, altered or withdrawn.
- Replacement of consumables.
- The use of non-original parts.
- Breakage of parts following impacts or projections.
- Accessories breakdowns.
- Defects and their consequences linked to any external cause.
- Loss of components and loss due to insufficient screwing.
- Cutting components and any damage related to the loosening of parts.
- Overload or overheating.
- Poor power supply quality: faulty voltage, voltage error, etc.
- Damages resulting from the deprivation of enjoyment of the product during the time necessary for repairs and more generally the costs related to the immobilization of the product.
- The costs of a second opinion established by a third party following an estimate by a SWAP-Europe repair station
- The use of a product which would show a defect or a breakage which was not the subject of an immediate report and/or repair with the services of SWAP-Europe.
- Deterioration linked to transport and storage\*.
- Launchers beyond 90 days.
- Oil, petrol, grease.
- Damages related to the use of non-compliant fuels or lubricants.

\* In accordance with transport legislation, damage related to transport must be declared to carriers within 48 hours maximum after observation by registered letter with acknowledgement of receipt.

This document is a supplement to your notice, a non-exhaustive list.

**Attention:** all orders must be checked in the presence of the delivery person. In case of refusal by the delivery person, it you must simply refuse the delivery and notify your refusal.

**Reminder:** the reserves do not exclude the notification by registered letter with acknowledgement within 72 hours.

**Information:** Thermal devices must be wintered each season (service available on the SWAP-Europe site). Batteries must be charged before being stored.

**HYUNDAI**  
POWER PRODUCTS

**For inquiries, please contact:**

BUILDER SAS

32 rue Aristide Bergès - Z.I. du Casque - 31270 Cugnaux - France

Tél.: +33(0)5.34.502.502 Fax.: +33(0)5.34.502.503

<http://www.hyundaipower-fr.com/>

Fabriqué en République Populaire de Chine(PRC)